



**FM8000**  
**Ultrasonic Open Channel Flow Meter**



January 2025



# TABLE OF CONTENTS

1 SYSTEM OVERVIEW.....	4
1.1 Receiving and Inspection of Product and Packaging.....	4
1.2 Safety and Operation .....	4
1.3 Warranty.....	4
1.4 SPECIFICATIONS.....	5
2 INSTALLATION.....	6
2.1 General.....	6
2.2 Controller Installation .....	6
2.3 Sensor Installation.....	7
2.4 WIRING & POWER.....	8
3 INITIAL START-UP & DISPLAY.....	12
3.1 Measuring Mode.....	12
3.2 Display A – General.....	12
3.3 Display B – Advanced.....	13
4 PROGRAMMING.....	14
4.1 Programming Buttons.....	14
4.2 Programming Mode.....	15
4.2.1 LEVEL.....	15
4.2.2 FLOW.....	19
4.2.3 RELAY.....	28
4.2.4 CURRENT OUTPUT.....	29
4.2.5 PULSE OUTPUT.....	31
4.2.6 COMMUNICATION SETUP.....	32
4.2.7 LOGGING SETUP.....	33
4.2.8 SYSTEM SETUP.....	35
4.2.9 NAVIGATION.....	38
5 MAINTENANCE.....	39
5.1 TROUBLESHOOTING - ERROR CODE LIST.....	39
6 RS-232/RS-485 PROTOCOL.....	40
6.1.1 Protocol.....	40
6.1.2 DATA.....	41
6.1.3 Modbus.....	42
7 ACCUVIEW SUPPORT SOFTWARE.....	43
7.1 Minimum Requirements.....	43
7.2 Program Installation.....	43
7.3 Initial Display.....	44
7.4 File Menu.....	45
7.5 View.....	46
7.6 About.....	47
7.7 Troubleshooting.....	47

# **1 SYSTEM OVERVIEW**

## ***1.1 Receiving and Inspection of Product and Packaging***

When opening the FM8000 packaging, inspect all cartons for damage that may have occurred during shipping. Carefully unpack equipment and inspect thoroughly for damage or shortage. Report any damage to carrier and/or shortages to supplier. DO NOT discard any boxes or packaging if damage has occurred.

## ***1.2 Safety and Operation***

In the interest of safety, the installation and operation of the FM8000 shall be performed by licensed or qualified professionals. Before powering the FM8000, please read his manual thoroughly. Flomotion Systems is not responsible for accidents caused by misuse or modification of the product.

## ***1.3 Warranty***

Flomotion Systems, Inc. warrants the FM8000 Series to be free of defects in material and workmanship for a period of one year from date of sale. Under normal use, if the FM8000 becomes defective within the stated warranty time period, contact Flomotion Systems, Inc. for return authorization prior to returning any product. Flomotion Systems, Inc. reserves the right to make the final determination as to the validity of a warranty claim, and sole obligation is to repair or replace only components, which have been rendered defective due to faulty material or workmanship. No warranty claim will be accepted for components which have been damaged due to mishandling, improper installation, unauthorized repair and/or alteration of the product, operation in excess of design specifications or other misuse, or improper maintenance. Flomotion Systems, Inc. makes no warranty that its products are compatible with any other equipment, or to any specific application, to which it may be applied and shall not be held liable for any other consequential damage or injury arising from the use of its products. This warranty is in lieu of all other warranties, expressed or implied. No other person, firm or corporation is authorized to assume, for Flomotion Systems, Inc., any other liability in connection with the demonstration or sale of its products.

## 1.4 SPECIFICATIONS

### FM8000 Controller

Measurement Method	Ultrasonic non-contacting
Accuracy	0.2% of F.S.
Resolution	0.04 in (1mm)
Data Logging Period	672 days (max. @1hr interval)
Output	Analog: 2 x 4-20ma, max 750 ohm Relay: 3, Form C, 8A at 250VAC Temperature Sensor Temperature Digital: RS-232, RS-485, Modbus
Display	Backlit LCD Graphics Display
NEMA Rating	NEMA 4X
Temperature	-4°F to 140°F (-20°C to 60°C)
Material	Polycarbonate
Dimensions	6.5w x 9.8h x 3.7d in. (166w x 250h x 95d mm)
Weight	4.4lb (2kg)
Power Supply	100-230VAC 50/60HZ, 35VA (17w) Fuse 250V T1.0A 9-30VDC, max 8W

### FM8000 S120 Sensor

Range	12ft
Beam Angle	8° at -3dB
Process Connection	1" NPT
Weight	2.2 lbs (1.0 kg)
Material	PVDF
Temperature	-22°F to 158°F (-30°C to 70°C) 80% RH Temperature compensated by built in sensor
NEMA Rating	NEMA 6P
Cable	2 Core Shield (AWG18) up to 1,476ft

### External Temperature Sensor

Type	NTC 10KΩ
Temperature	-22°F to 158°F (-30°C to 70°C)
Process Connection	1/8" PT
NEMA Rating	NEMA 6P
Cable	RG174

Specifications subject to change without prior notice

## 2 INSTALLATION

### 2.1 General

FM8000 shall be used in accordance with manufacture's specifications.

### 2.2 Controller Installation

Open controller door and check the four screw holes.

- Level controller.
- Mark and drill the four holes for wall mounting.
- Secure fasteners for the wall mount installation.

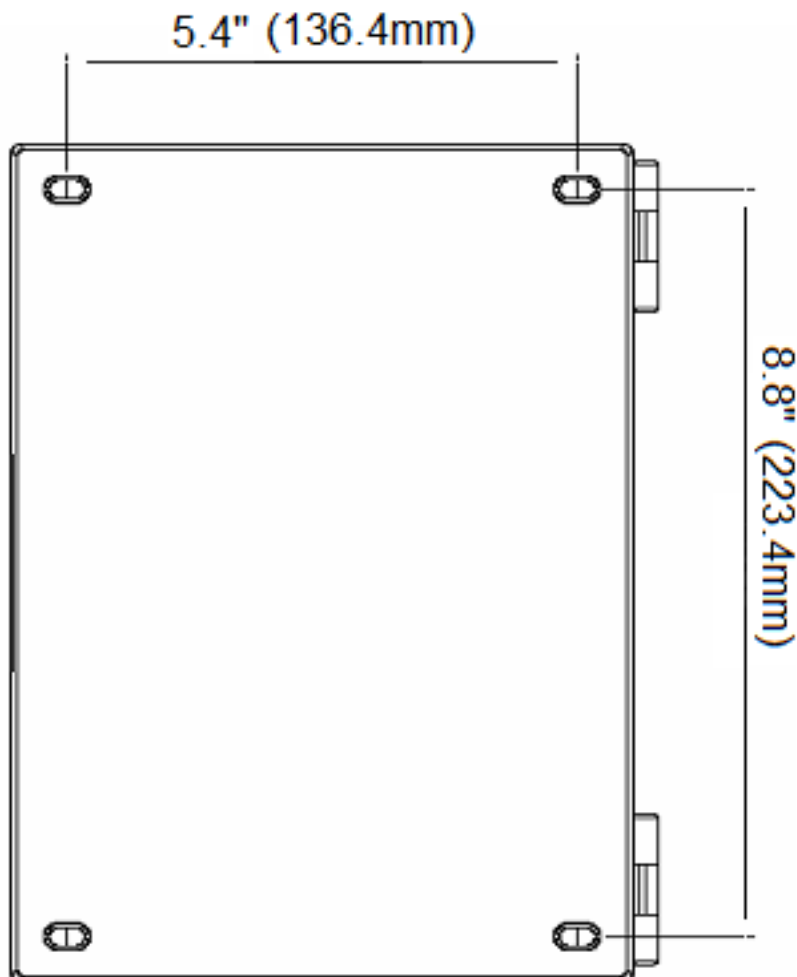

## 2.3 Sensor Installation

The S120 sensor is constructed of PVDF. Please verify chemical compatibility with process before installation.

- The S120 sensor has a 1" NPT (M) for mounting.
- Remove any obstacles between the sensor and measurement point.
- The bottom of the sensor should be perpendicular to the measurement point.
- Avoid mounting the sensor too close to a wall.
- Avoid setting a maximum level into the Dead Zone range.
- Avoid the exposure to direct sunlight.
- Avoid high voltage or high current lines.
- Install on solid, non-vibrating surface.

MEASUREMENT DISTANCE	BEAM WIDTH (A)
36"	2.75"
72"	5.5"
108"	8.25"
144"	11"

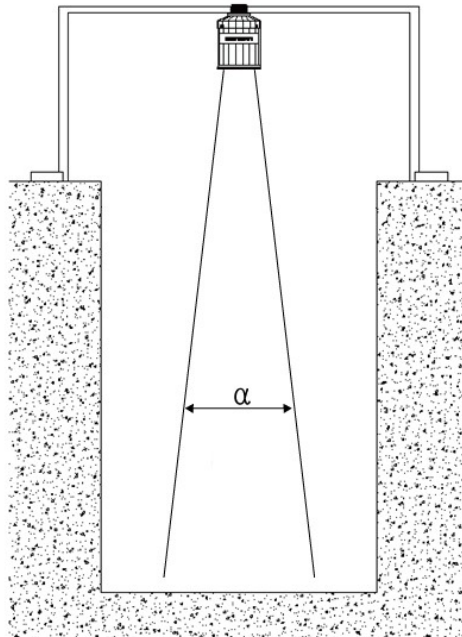

## 2.4 WIRING & POWER

### CPU Board

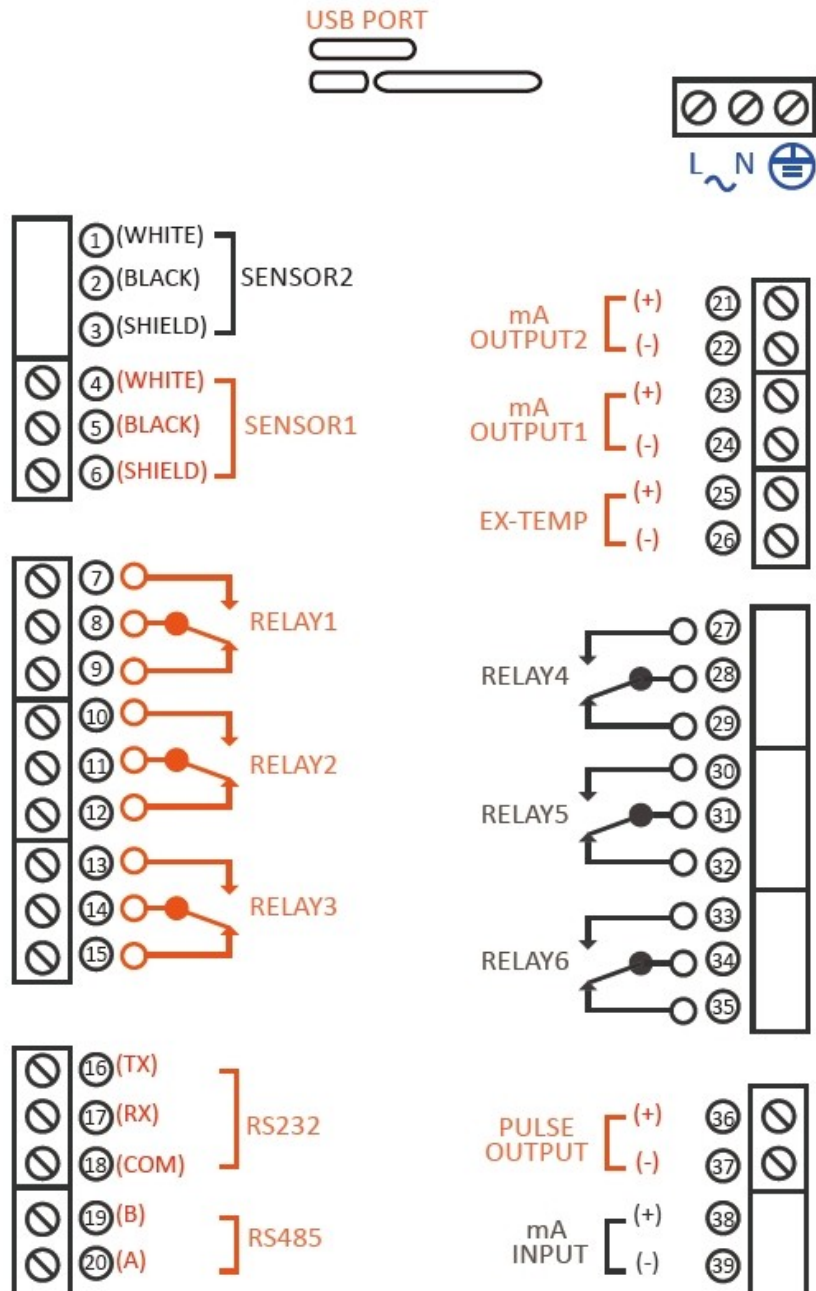



## Transducer

Use SENSOR 1 terminal block for S120 wiring. SENSOR 2 terminal block is NOT available.

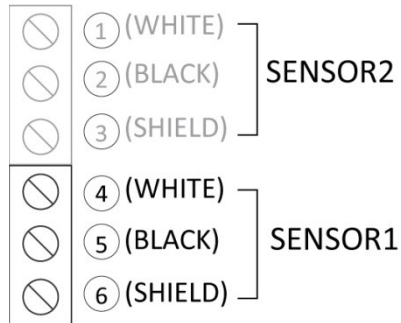

## Power

Provide the appropriate voltage to the correct terminal. Provide 100-230VAC, 50/60Hz to AC power terminal as standard. OPTIONAL 9-30VDC power input is available upon request. If the FM8000 is ordered with the optional DC power input, provide 9-30VDC power to the DC power terminal.

### AC Power Terminal

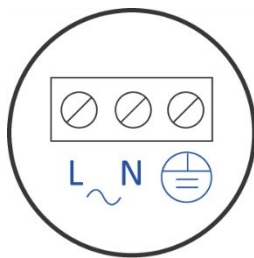

### DC Power Terminal

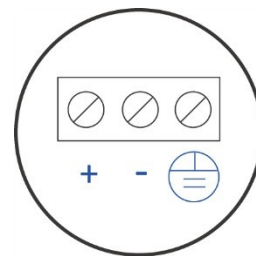

### Relay

Three form C, 8A, @ 250VAC relays are provided. The relays can be wired normally open or normally closed.

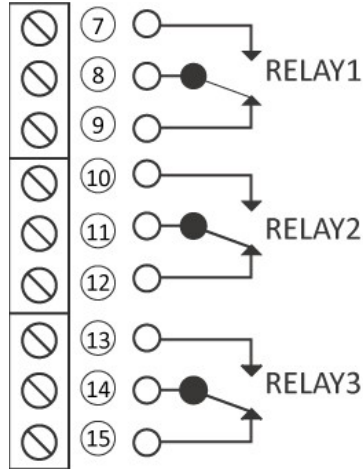

### Temperature Sensor (Optional)

Temperature input is a critical factor for accurate measurement. The S120 sensor has a built-in temperature sensor. If the ambient temperature changes rapidly, an external temperature sensor is recommendable.

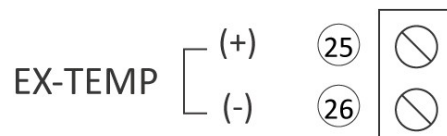

### Analog Output

Two 4-20mA outputs are provided for level and flow measurement.

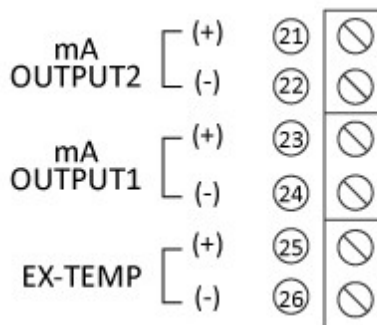

## Pulse Output

The measured flow value is converted into a pulse.

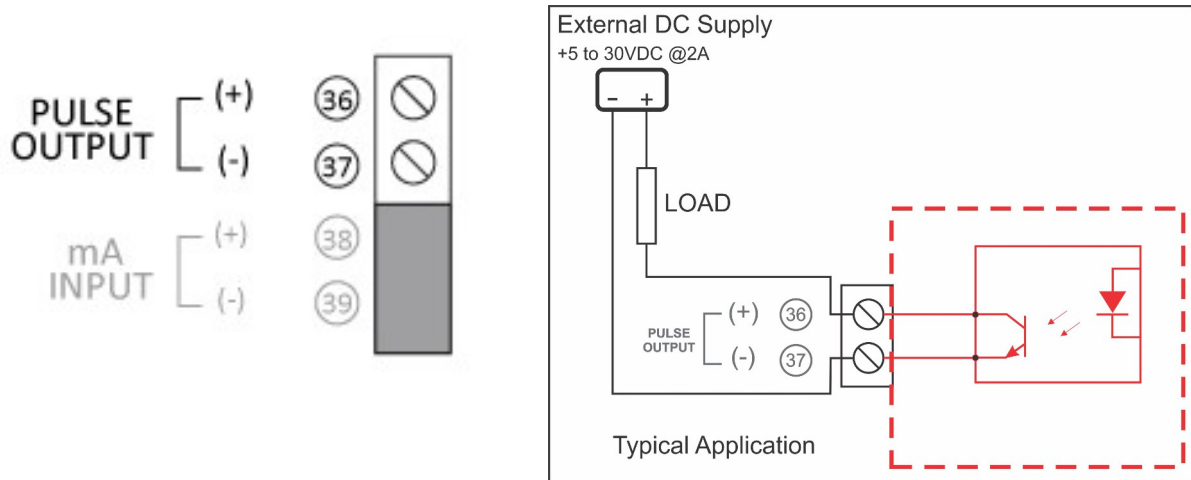

## Digital Communication

RS-232 communication is standard. RS-485 and Modbus are options.

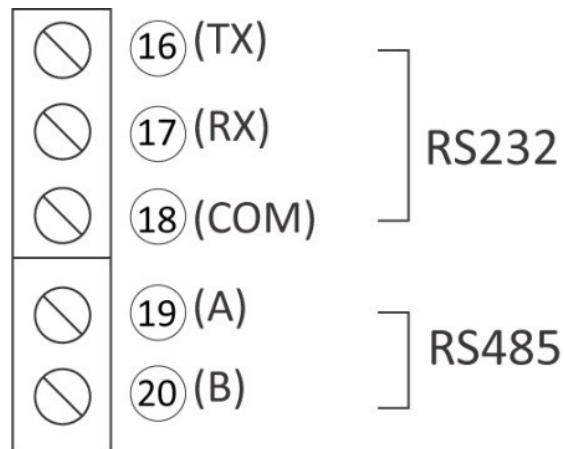

## Sensor Cable

Grounded metallic conduit is recommended for the transducer cable installation to help eliminate any outside interference.

### 3 INITIAL START-UP & DISPLAY

When power is applied, the current software version is displayed.

#### 3.1 Measuring Mode

There are 3 different measuring mode displays. To change between display modes, press the up and down buttons.

#### 3.2 Display A – General

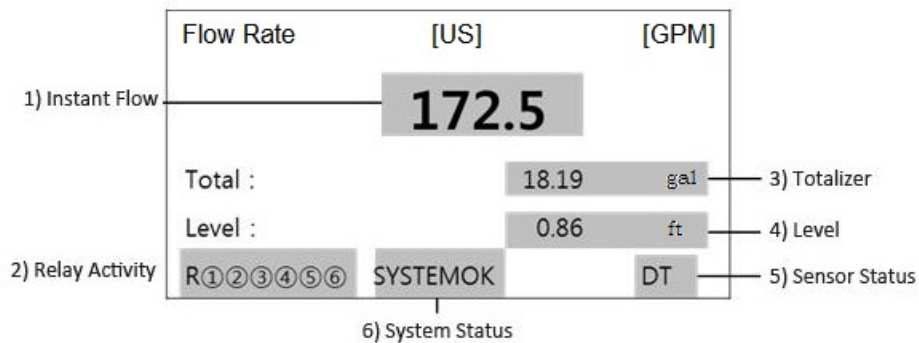

1. Current Flow Rate
2. Relay Status
3. Current Total Flow
4. Current Level
5. Sensor Status
  - DT: Normal Operation
  - D: Receipt of deflective signal
  - S1: Measurement value is over DAMPENING SPEED (the value is held)
  - S2: Analyzing Signal
  - LE: Lost Echo/Signal
6. System Status
  - SYSTEM OK: Normal Operation
  - SYSTEM OPEN: Sensor is not wired or cut/damaged cables
  - FAIL: Unable to read level and convert to flow

### 3.3 Display B – Advanced

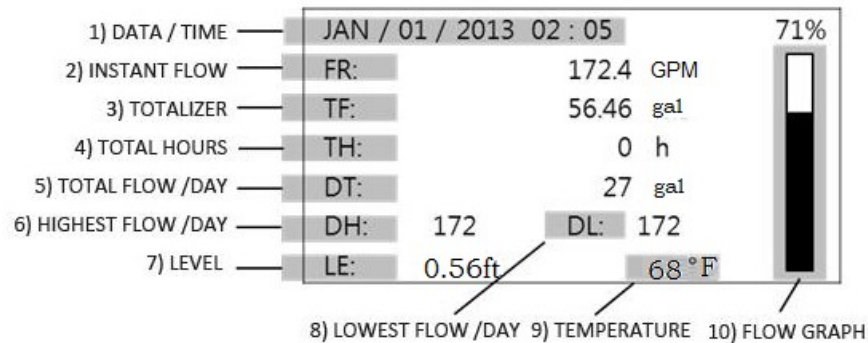

7. Time and Date
8. Current Flow Rate
9. Current Total Flow
10. Total Hours Measured
11. Current Daily Total
12. Current Daily High Flow
13. Current Level
14. Current Daily Low Flow
15. Current ambient temperature being measured from sensor
16. Flow graph

### 3.4 Display C – Echo Trend Display

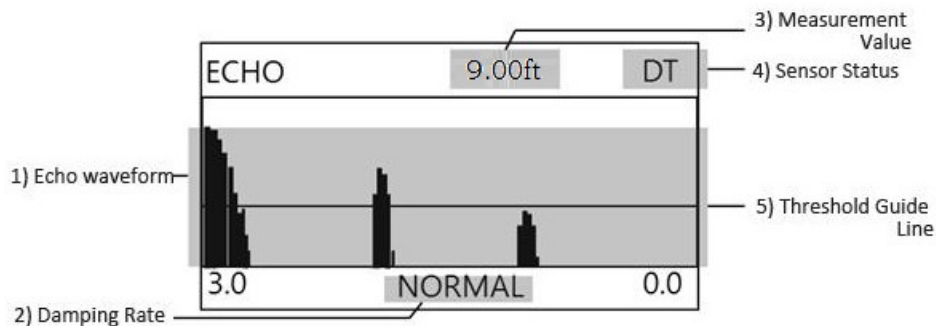

1. Echo waveform received by sensor
2. Current dampening selected in programming mode
3. Current measured value
4. It shows the sensor condition
  - DT: Normal Operation
  - D: Receipt of deflective signal
  - S1: Measurement value is over DAMPENING SPEED (the value is held)
  - S2: Analyzing Signal
  - LE: Lost Echo/Signal
5. Threshold guide line

## 4 PROGRAMMING

### 4.1 Programming Buttons

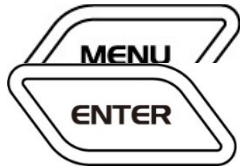

Enters Programming Mode and Measuring Mode.

Select a parameter in Programming Mode.  
Accepts parameter setting.



Changes Display Mode

When programming: Changes parameters or parameter setting.



Changes Display Mode

When programming: Changes parameters or parameter setting.



Return to the previous parameter.  
Moves the cursor to the left when entering numbers.



Advance to the next parameter.  
Moves the cursor to the right when entering numbers.

## 4.2 Programming Mode

1. LEVEL
2. FLOW
3. RELAY
4. CURRENT OUTPUT
5. PULSE OUTPUT
6. COMMUNICATION SETUP
7. LOGGING SETUP
8. SYSTEM SETUP
9. NAVIGATION

### 4.2.1 LEVEL

[1000] LEVEL	
UNIT	in
TEMP UNIT	°F
EMPTY	48.00 in
AUTO EMPTY	SETUP
DEAD ZONE	12 in
TX POWER	030
RX GAIN	080
THRESHOLD	4[0.8v]
TEMP TYPE	INSIDE
TEMP FIX	°F
TEMP	CURRENT TEMP °F
DAMPENING	NORMAL
SOUND SPEED	0331.5
SOUND SPEED FACTOR	+0.60

### Unit

[Default: in]

Range: ft, in, yd, m, cm, mm

Value being measured.

### Temp Unit

[Default: °F]

Range: °F or °C

Selection of the unit displays the temperature value.

### Empty

[Default: 48.00 in]

Range: 00.00 - 12.00ft

Sets the distance between the bottom of the sensor and the “0” flow point in the measuring device.

Sensor	Maximum Range	Default
S120	12ft.	12ft.

### Auto Empty

[Default: SETUP ft]

Automatically sets the distance between the bottom of the sensor and the “0” flow point in the measuring device. A “0” flow condition must be achieved in order to select this option.

### Dead Zone

[Default: 12 in]

Range: 00.82 - 12ft

Sets the distance from the face of the transducer to the closest readable level.

Sensor	Setting	Default
S120	Minimum 1.0ft.	1.0ft.

### TX Power

**Do not change from default unless measurement issues occur.**

[Default: 030]

Range: 001 - 100

Adjusts the sensitivity of the signal output from the sensor.

- 10: Low Power - Use for short range applications
- 30: Normal Power - Use in normal conditions
- 50: High Power - Use in long range measurement
- 100: Maximum Power - Use in dusty, steamy or turbulent applications.



## **RX Gain**

[Default: 080]

**Do not change from default unless measurement issues occur.**

Adjusts the sensitivity of the signal received from the sensor.

Range: 000 - 100

- 30 or less: For use in non-standard short-range applications.
- 50: For use in non-standard semi-short-range applications.
- 80: For use in normal applications.
- 90: For use in long-range measurement
- 95: For use in long-range measurement dusty, steamy or turbulent applications.

## **Threshold**

[Default: 4[0.8V] Default is 4 and is acceptable for most applications.

Range is 1-10

**Do not change from default unless measurement issues occur.**

Sets the detection of the returned echo. For noisy applications increase the detect threshold. For detection or weak signals, decrease the detect threshold value.

## **Temp Type**

[Default: INSIDE]

- INSIDE: Select when using the temperature inside the ultrasonic sensor.
- OUTSIDE: Select when using (optional) external temperature sensor.
- FIX: Select when desired temperature setting is fixed or constant.

## **Temp Fix**

[Default: °F]

Enter the desired temperature when FIX temp is selected in parameter 9.

## **Temp**

[Default: °F]

Displays current measured temperature reading.

## **Dampening**

**Do not change from default unless measurement issues occur.**

[Default: NORMAL]

Range: SLOW, NORMAL, FAST, V FAST

Sets the displayed value response time.

## Sound Speed

[Default: 331.5 (Air)]

Sets the sound velocity to be changed according to the atmosphere the transducer is operating in.

<i>Chlorine</i>	<i>206</i>
<i>Carbon dioxide</i>	<i>259</i>
<i>Argon</i>	<i>308</i>
<i>Oxygen</i>	<i>316</i>
<i>Air</i>	<i>331.5</i>
<i>Ammonia</i>	<i>415</i>
<i>Ethane</i>	<i>430</i>
<i>Neon</i>	<i>435</i>
<i>Helium</i>	<i>965</i>

## Sound Speed Factor

**Do not change from default unless measurement issues occur.**

[Default: +0.60]

## 4.2.2 FLOW

[2000] FLOW	
[2100]	FLOW UNIT
[2200]	DEVICE SELECTION
[2300]	LOW CUT VALUE
[2400]	HIGH CUT VALUE
[2500]	TOTALIZER
[2600]	FR RATIO
[2700]	FLOW INDEX

### FLOW UNIT

[Default: GPM [US]]

[2100] FLOW UNIT
FLOW UNIT
GPM [US]

Range:

FLOW RATE	TOTAL FLOW
m <sup>3</sup> /h	m <sup>3</sup>
m <sup>3</sup> /d	m <sup>3</sup>
l/min	KL[Kilo Liter]
ft <sup>3</sup> /s	ft <sup>3</sup>
GPM[US]	gal[US]
GPM[UK]	gal[UK]
MGD[US]	MGD[US]
MGD[UK]	MGD[UK]

## DEVICE SELECTION

[2200] DEVICE SELECTION	
1	Parshall Flume
2	Rect. Suppressed
3	Rect. Contracted
4	V-Notch Weir
5	Cipolletti Weir
6	Leopold Lagco Flume
7	Palmer Bowlus Flume
8	H Flume
9	TRAPEZOIDAL Flume
10	DIY Curve/Special

Selected device is marked by “\*”

[2200] DEVICE SELECTION
* Parshall Flume
2. Rect. Suppressed
.....
10. DIY Curve/Special

**Parshall Flume**

[Default: 1in]

[2210] 1. Parshall Flume
1. Parshall Flume
1 in

Range:

Parshall Flume	Maximum Height [ft]	Parshall Flume	Maximum Height [ft]
1 in	.7	1 ft	2.5
2 in	.8	1.5 ft	2.5
3 in	1.5	2ft	2.5
6 in	1.5	3 ft	2.5
9 in	2	4 ft	2.5
		5 ft	2.5
		6 ft	2.5
		8 ft	2.5
		10 ft	2.75
		12 ft	3.5

**Rect. Suppressed**

[Default: 1ft]

[2220] 2. Rect. Suppressed
2. Rect. Suppressed
1 ft

Range:

Rect. Suppressed	Maximum Height [ft]	Rect. Suppressed	Maximum Height [ft]
1 ft	.5	4 ft	2
1.5 ft	.75	5 ft	2.5
2 ft	1	6 ft	3
2.5 ft	1.25	8 ft	4
3 ft	1.5	10 ft	5

**Rect. Contracted**

[Default: 1ft]

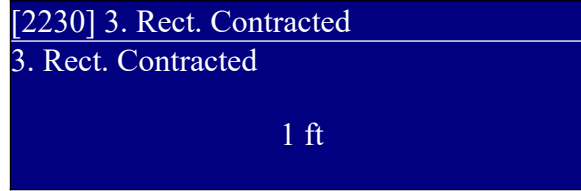

Range:

Rect. Contracted	Maximum Height [ft]	Rect. Contracted	Maximum Height [ft]
1 ft	.5	4 ft	2
1.5 ft	.75	5 ft	2.5
2 ft	1	6 ft	3
2.5 ft	1.25	8 ft	4
3 ft	1.5	10 ft	5

If there is no channel installed on the menu, please complete the following steps.

At [2293] Rectangular Weir Menu, please select Suppressed Weir and enter the corresponding Crest Length.

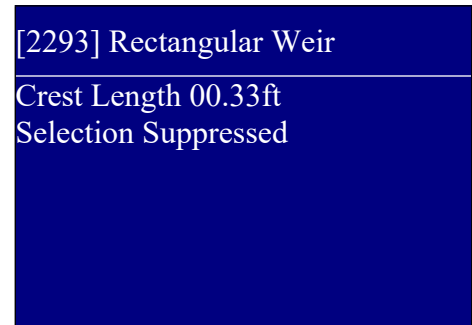
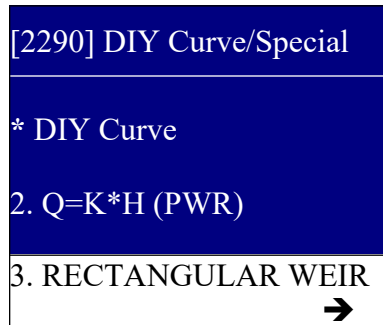
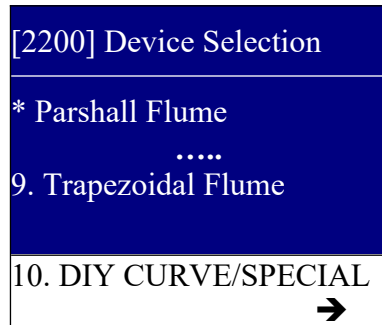

**V-Notch Weir**

[Default: 22.5°]

Range: 22.5°, 30°, 45°, 60°, 90°, 120°



### Cipolletti Weir

[Default: 1ft]

[2250] 5. Cipolletti Weir
5. Cipolletti Weir
1ft

Range:

Cipolletti Weir	Maximum Height [ft]	Cipolletti Weir	Maximum Height [ft]
1 ft	.5	4 ft	2
1.5 ft	.75	5 ft	2.5
2 ft	1	6 ft	3
2.5 ft	1.25	8 ft	4
3 ft	1.5	10 ft	5

### Leopold Lagco Flume

[Default: 4 in]

[2260] 6. Leopold Lagco Flume
6. Leopold Lagco Flume
4 in

Range:

Leopold Lagco Flume	Maximum Height [ft]	Leopold Lagco Flume	Maximum Height [ft]
4"	.24	15"	.9
6"	.35	18"	1.05
8"	.45	21"	1.25
10"	.6	24"	1.4
12"	.7	30"	1.75

**Palmer Bowlus Flume**

[Default: 4 in]

[2270] 7. Palmer Bowlus Flume
7. Palmer Bowlus Flume
4 in

Range:

Palmer Bowlus Flume	Maximum Height [ft]	Palmer Bowlus Flume	Maximum Height [ft]
4"	.25	15"	.9
6"	.35	18"	1.05
8"	.5	21"	1.25
10"	.6	24"	1.4
12"	.7	30"	1.75

**H Flume**

[Default: 0.5 H]

[2280] 8. H Flumes
8. H Flumes
0.5 H

Range:

H Flumes	Maximum Height [ft]	HS Flumes	Maximum Height [ft]	HL Flumes	Maximum Height [ft]
0.5 H	.5	0.4 HS	.4	3.0 HL	3
0.75 H	.75	0.6 HS	.6	4.0 HL	4
1.0 H	1	0.8 HS	.8		
1.5 H	1.5	1.0 HS	1		
2.0 H	2				
2.5 H	2.5				
3.0 H	3				
4.5 H	4.5				



**TRAPEZOIDAL Flume**

[Default: Sm. 60° V]

[2281] 9. TRAPEZOIDAL Flume
9. TRAPEZOIDAL Flume
Sm. 60°V

Range:

TRAPEZOIDAL Flume	Maximum Height [ft]	TRAPEZOIDAL Flume	Maximum Height [ft]
Sm. 60° V	.3	2" 45° WSC	.83
Lg. 60° V	.56	12" 45° SRCRC	1.21
XL 60° V	1	2.0' SRCRC	2
3.0' 60° V	3		

**DIY Curve/Special**

[2290] DYI Curve/Special
1. DIY Curve
2. Q=K*H (PWR)
3. Rectangular Weir

**DIY Curve**

[Default: 12ft]

Allows for 10 point custom level/flow chart.

Range: 0.05xMH - 1.00xMH

[2291] DYI Curve [USGPM]
MAX HEIGHT      12.00ft
0.05xMH          000000.0
0.10xMH          000000.0
.....
1.00xMH          000000.0

### Q=K\*H (PWR)

This option inputs constant values, K and PWR, to a exponentially changing device and measures the flow rate.

Range: K: 00000.0001 - 99999.9999

PWR: 0.001 - 9.999

H: ft, in, yd, m, cm, mm

Q: m<sup>3</sup>/h, m<sup>3</sup>/d, l/min, ft<sup>3</sup>/s, GPM[US], GPM[UK], MGD[US], MGD[UK]

[2292] Q=K*H (PWR)	
K	00000.0001
PWR	0.001
H	ft
Q	GPM[US]

### Rectangular Weir

This option selects Crest Length of all Rectangular Weir and measures the flow rate.

[Default: Crest Length: 1ft]

Selection: Suppressed Weir

Range: Crest Length: 0.00 - 30.00ft

Selection: Suppressed Weir or Contracted Weir

[2293] Rectangular Weir	
Crest Length	00.33ft
Selection	Suppressed

### LOW CUT VALUE

[Default: 000000.0 GPM[US]]

Range: 000000.0 - Max. Peak Flow

Sets the lowest desired flow rate to be displayed. Any flow rate under value will read zero.

[2300] LOW CUT VALUE	
LOW CUT VALUE	
000000.0 GPM [US]	

**HIGH CUT VALUE**

[Default: 000000.0 GPM[US]

Range: 000000.0 - Max. Peak Flow

Sets the highest desired flow rate to be displayed. Any flow rate over value will read entered value.

[2400] HIGH CUT VALUE
HIGH CUT VALUE
000000.0 GPM [US]

**TOTALIZER**

Modifies the TOTAL FLOW and TOTAL TIME.

**TOTAL FLOW SET** [Default: 00000000000 gal]

**TOTAL TIME SET** [Default: 000000001h]

[2500] TOTALIZER
TOTAL FLOW SET
TOTAL TIME SET

[2510] TOTAL FLOW SET
00000000000 gal

[2510] TOTAL TIME SET
000000001h

**FR RATIO**

Allows for customer correction of the flow rate without changing level.

Range: User Defined

[2600] FR RATIO [USGPM]
FR RATIO 1.000
FR 00000.00
LE 0.00ft

Note: When FR RATIO is 1.00, FR is 2.00, If FR RATIO is changed to 1.100, the FR value will be 2.20 and the LE value does not change.

## FLOW INDEX

Indicates the high flow rate for the as programmed per the device selection.

Range: User Defined

[2700] FLOW INDEX	
FLOW INDEX	00.000ft
m <sup>3</sup> /h	0.000
GPM	0.000

## 4.2.3 RELAY

Relay 1 - 3

[3000] RELAY	
RELAY 1	
RELAY 2	
RELAY 3	
RELAY SIMULATION	

[3100] RELAY 1	
DETAIL	
ON POINT	
OFF POINT	

[3110] DETAIL	
FUNCTION	NONE
GROUP	1

### DETAIL

Range:

#### FUNCTION:

- NONE: Relay outputs not being used.
- LIMITED: Enables each relay independently via the ON/OFF set points
- ALTERNATE: Enables each relay to alternate in sequence via the measured value and the ON/OFF set points.
- ALARM: Enables relay via Fail Safe Time Alarm

#### GROUP: 1 or 2

Sets the relay in which to alternate id. Alternate is selected in parameter 1.

## ON POINT

```
[3120] ON POINT
ON POINT
000000.0 GPM [US]
```

## OFF POINT

```
[3220] OFF POINT
OFF POINT
000000.0 GPM [US]
```

## RELAY SIMULATION

[Default: RELAY 1, RELAY 2, RELAY 3 - OFF  
Range: Test ON/OFF function of relay.

```
[3400] RELAY SIMULATION
RELAY 1          OFF
RELAY 2          OFF
RELAY 3          OFF
```

## 4.2.4 CURRENT OUTPUT

```
[4000] CURRENT OUTPUT
CURRENT OUTPUT 1
CURRENT OUTPUT 2
CURRENT SIMULATION
```

```
[4100] CURRENT OUTPUT 1
INPUT TYPE
4mA POINT SET
20mA POINT SET
FAIL SAFE CURRENT
```

```
[4200] CURRENT OUTPUT 2
INPUT TYPE
4mA POINT SET
20mA POINT SET
FAIL SAFE CURRENT
```

### Input Type

[Default: FLOW]

- LEVEL
- FLOW

[4110] INPUT TYPE
INPUT TYPE
LEVEL

### 4mA Point Set

[Default: 000000.0 GPM [US]

Sets 4mA value for input type selected.

[4120] 4mA SET POINT
4mA POINT SET
000000.0 GPM [US]

### 20mA Point Set

[Default: 000000.0 GPM [US]

Sets 20mA value for input type selected

[4130] 20mA POINT SET
20mA POINT SET
000000.0 GPM [US]

### Fail Safe Current

[Default:

Sets current output when an error occurs

- 3.8mA
- HOLD
- 22mA

[4140] FAIL SAFE CURRENT
FAIL SAFE CURRENT
3.8mA

## Current Simulation – Output 1 & Output 2

[4300] CURRENT SIMULATION	
OUTPUT 1	MEASURE
OUTPUT 2	MEASURE

Range: Select current simulated value below for Current Output 1 and 2.

- 3.8mA
- 4mA
- 12mA
- 20mA
- 22mA

## 4.2.5 PULSE OUTPUT

[5000] PULSE OUTPUT	
FUNCTION	ENABLE
PULSE WIDTH	0.10 sec
PULSE VALUE	000000 gal

### FUNCTION

[Default: ENABLE]

Range:

- **DISABLE:** Pulse Output not being used.
- **ENABLE:** Pulse Output turned on

### Pulse Width

[Default: 0.10 sec]

Adjusts the pulse width.

Setting Range: 0.01- 1.00 sec

### Pulse Value

[Default: 000000gal]

Range: 1 – 9999999gal

Pulse value corresponding to total flow engineering unit selected.

## 4.2.6 COMMUNICATION SETUP

### [6000] COMMUNICATION SETUP

RS-232 SETUP

RS-485 SETUP

### RS-232 & RS-485 Setup

[6100] RS-232 SETUP	
USE	ENABLE
BAUDRATE	9600
PARITY	NONE
STOP BIT	1
DATA BIT	8
PROTOCOL	FLOMOTION

[6200] RS-485 SETUP	
USE	Enable
BAUDRATE	9600
PARITY	None
STOP BIT	1
DATA BIT	8
PROTOCOL	FLOMOTION

Range:

#### USE

This menu is for selecting the RS-232 use state.

- ENABLE [Default]
- DISABLE

#### BAUDRATE

This menu is for selecting the transmission speed of RS-232

- 4800 bps
- 9600 bps [Default]
- 14400 bps
- 19200 bps
- 38400 bps
- 57600 bps
- 115200 bps

#### PARITY

- NONE [Default]
- ODD
- EVEN

#### STOP BIT

Selects the size of the Stop Bit of RS-232 data transmission

- 1 bit [Default]
- 2 bit



## DATA BIT

Selects the size of the transmission data of RS-232

- 8 bit [Default]
- 9 bit

## PROTOCOL

Selects the protocol that is output by RS-232

- Flomotion [Default]
- KICT

## 4.2.7 LOGGING SETUP

Make sure the flash drive is formatted with a FAT32 format and size is 16GB or smaller. Also, always eject the USB drive when removing it from a computer rather than just unplugging it. That can lead to file open errors if not ejected properly.

```
[7000] LOGGING SETUP
LOGGING PERIOD
LOGGING ERASE
USB LOGGING
```

### Logging Period

[Default: NONE]

```
[7100] Logging Period
Logging Period

None
```

Range:

Data Logging Period	Maximum Storage Period
10 sec	2 days
1 minute	11 days
5 minute	56 days
10 minute	112 days
15 minute	168 days
30 minute	336 days
60 minute	672 days

Maximum data logging memory (16,128 points)

### Logging Erase

Screen will be displayed as shown below. Selecting OK, will erase all logged data.

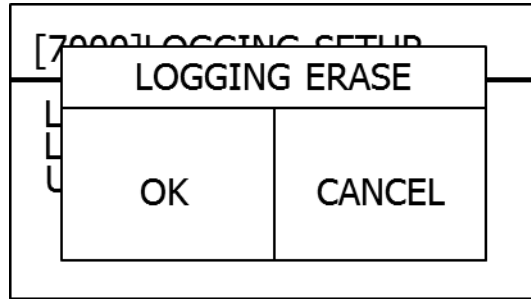

### USB Logging

When USB is connected, screen will be displayed as below. By selecting OK, it transfers logged data to USB as EXCEL file.

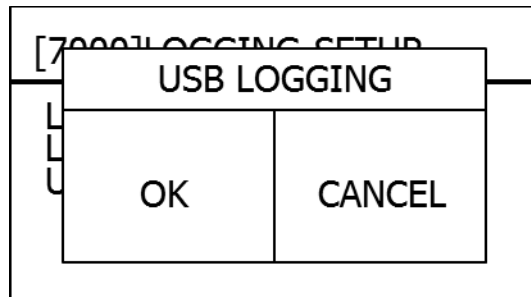

When USB is not connected, screen will be displayed as below. Please connect USB, and then click the (enter) OK button, the error message will disappear.

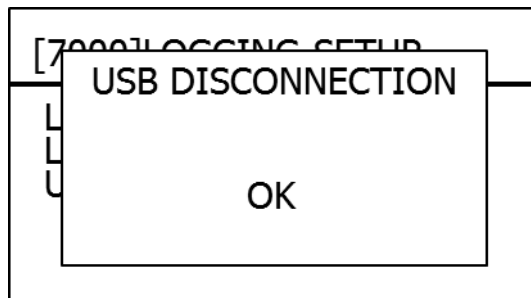

## 4.2.8 SYSTEM SETUP

[8000]	SYSTEM SETUP
SYSTEM INFO	
SYSTEM ID	
SYSTEM TIME	
PASSWORD	
LANGUAGE	
FAIL SAFE TIME	
BACKUP PARAMETER	
RESET	

### System Info

[8100]	SYSTEM INFO
VERSION	1.1.6
SYSTEM ID	0
UNIT	FEET

- VERSION: Firmware version
- SYSTEM ID: System ID for Flomotion protocol
- UNIT: Engineering Unit Selected programmed by user.

### System ID

[Default: 0]

Range: 0 - 99

Sets the System ID to be used for Flomotion Protocol.

### Modbus ID

[Default: 001]

Range: 001 - 247

Sets the Slave ID required when using Modbus Protocol

[8200]	SYSTEM ID
SYSTEM ID	0
MODBUS ID	001

## System Time

[8300] SYSTEM TIME
SYSTEM TIME
JAN/01/2013/05:54

## Password

[Default: 0000] It is not recommended to change. If password is changed and forgotten, the meter will need to be sent back to the factory.

[8400] PASSWORD
PASSWORD
0000

## Language

[8500] LANGUAGE
LANGUAGE
ENGLISH

## Fail Safe Time

[Default: 300 sec]

Range: 20 - 999

Sets the time the FAIL SAFE value is held.

[8600] FAIL SAFE TIME
FAIL SAFE TIME
300 sec

### Backup Parameter

Accepts the user selected parameters.

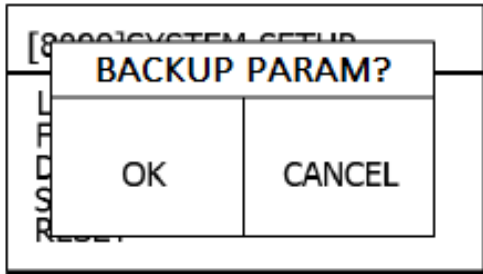

### Reset



### Factory Reset

Resets programming to the original factory settings.

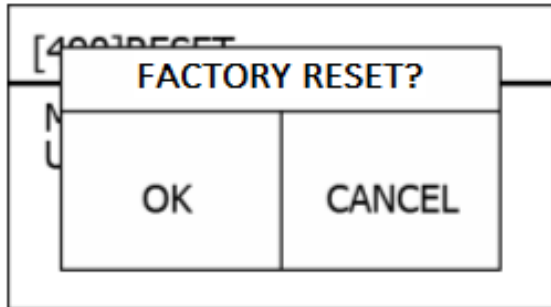

### User Param Set

Resets programming to the user selected parameters if saved during setting backup function.

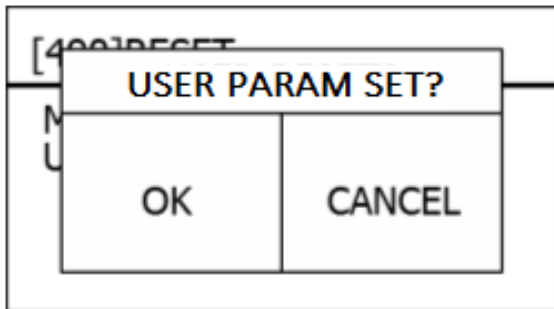

## 4.2.9 NAVIGATION

Allows for quick access to specific parameters directly by entering the preset number.

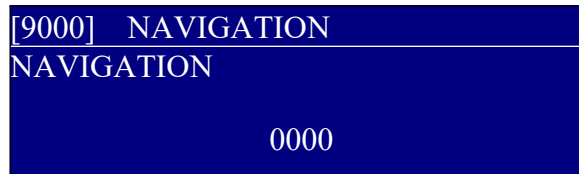

Note: if you want to access Logging Period, please enter menu number 6100.

## 5 MAINTENANCE

Sensor - Inspect the face for dirt or debris. Wipe clean if necessary.

### 5.1 TROUBLESHOOTING - ERROR CODE LIST

<b>E0101</b>	Error appears when sensor 1 is not connected to the terminal or it is connected to the
<b>E1101</b>	terminal incorrectly.
<b>E1102</b>	Error appears when the built-in temperature sensor in sensor 1 is not operating properly.
<b>E0401</b>	Error appears when an external thermometer that connected to the controller is not operating properly.
<b>E0201</b>	Error appears when the flash memory inside controller is not operating properly.
<b>E0202</b>	(1) Error appears when the EPROM memory inside controller is not operating properly.
<b>E0203</b>	Error appears when the REAL TIME CLOCK inside of the controller is not operating properly.
<b>E0204</b>	Error appears when the received signal from sensor 1 is abnormal. "LE" will be flashing on the screen.

## 6 RS-232/RS-485 PROTOCOL

### 6.1.1 Protocol

#### Data Output Format

Data format is ASCII and the Data information is as follows:

Data field	DATA START					SYSTEM ID				YEAR
Byte number	1	2	3	4	5	6	7	8	9	10
Data		D	A	T	A		0	0		2
Data field	YEAR				MONTH			DAY		
Byte number	11	12	13	14	15	16	17	18	19	20
Data	0	1	3		1	2		0	3	
Data field	HOUR			MINUTE			SECOND		UNIT	
Byte number	21	22	23	24	25	26	27	28	29	30
Data	1	0		5	0		1	5		M
Data field	UNIT	LEVEL						FLOW RATE		
Byte number	31	32	33	34	35	36	37	38	39	40
Data		0	0	0	0	0	0		0	0
Data field	FLOW RATE					TOTAL FLOW				
Byte number	41	42	43	44	45	46	47	48	49	50
Data	0	0	0	0		0	0	0	0	0
Data field	TOTAL FLOW				TEMPERATURE UNIT		TEMPERATURE			
Byte number	51	52	53	54	55	56	57	58	59	60
Data	0	0	0	0		C		+/-	0	0
Data field	TEMPERATURE		DATA END							
Byte number	61	62	63	64	65					
Data	0	0		\n	\r					

The gray column in the table above means space (0\*20).

Data Output (e.g.): DATA 01 2013 01 01 01 06 15 M 009.60 000.00 009.60 -09.60 000188.46  
000000.00 C +0024.0 +0000.0



## 6.1.2 DATA

1. System ID
2. Year/Month/Day/Minute/Second
3. Measurement Unit
4. Level
5. Flow Rate
6. Total Flow
7. Temperature Unit
8. Temperature
9. Data End

UNIT	LEVEL	FLOW RATE	TOTAL FLOW
m	Meter	m <sup>3</sup> /h	m <sup>3</sup>
c	Centimeter	m <sup>3</sup> /h	m <sup>3</sup>
mm	Millimeter	m <sup>3</sup> /h	m <sup>3</sup>
ft	Feet	GPM[US]	gal[US]
in	Inch	GPM[US]	gal[US]
yd	Yard	GPM[US]	gal[US]
°F	Fahrenheit		
°C	Celsius		

### 6.1.3 Modbus

The FM8000 provides Modbus RTU frame format and Modbus ASCII frame format. All data register codes are read holding registers. Modbus ID can be set from 1 to 247. (Relevant menu SYSTEM SET-UP (8000) > SYSTEM ID > MODBUS ID)

#### Modbus DATA Register Table

#### Request PDU Example

Product Code Request

Function Code	Data Request	
	Register Offset	Quantity
0 X 03	0 X 8000	0 X 0001

Distance, Level, Flow Rate, Total Flow Request

Function Code	Data Request	
	Register Offset	Quantity
0 X 03	0 X 8000	0 X 0002
0 X 03	0 X 8012	0 X 0002
0 X 03	0 X 8014	0 X 0002
0 X 03	0 X 8016	0 X 0002

#### Modbus Register Data Type

- Data Field: 4 Byte Float Type
- ID, UNIT, Relay Field: Unsigned Short (2 byte) Type

## 7 ACCUVIEW SUPPORT SOFTWARE

### 7.1 Minimum Requirements

#### OS & Library

OS: Microsoft Windows XP or Windows 7 32bit/64bit

Library: Microsoft.net Framework v. 3.5, MS Chart for .net Framework 3.5 library

#### Hardware

CPU: 32bit or 64bit Intel Pentium 3 1Ghz

Memory: 256MB

Port: RS-232 port (when receiving the data from the control board through RS-232)

### 7.2 Program Installation

#### Installing Program File

The file is provided by the supplied CD or internet (flomotionsystems.com). Click the AccuviewInstaller.msi

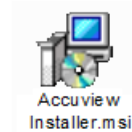

#### Installing Process

Select the options in each process and click the [Next] button.

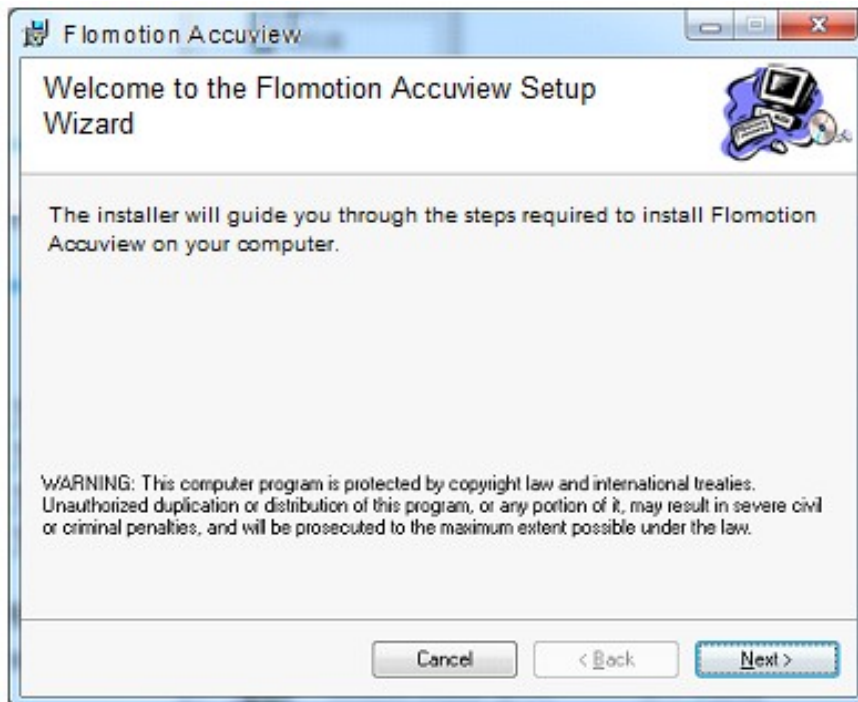

## Running Program

The directory “Flomotion” is created in the computer. Click Flomotion Accuview.

### 7.3 Initial Display

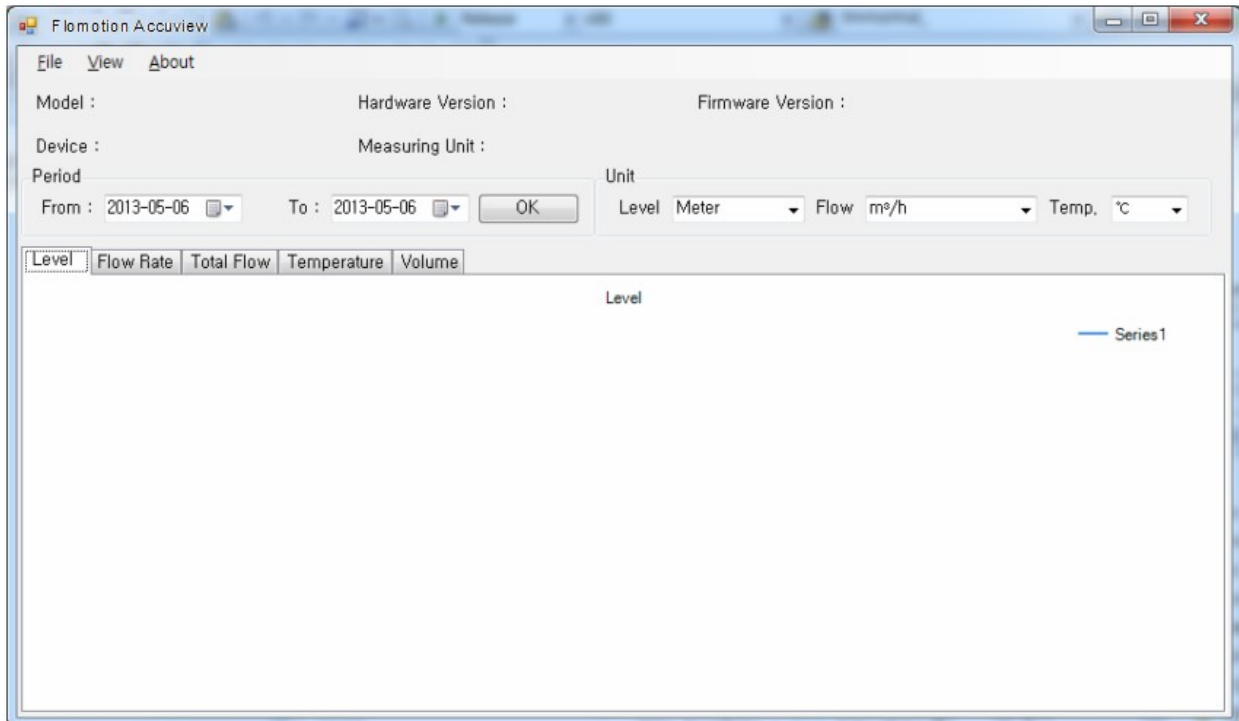

## 7.4 File Menu

### Open

The flow data format is CSV. This menu is to open the CSV files.

### Save

This menu is to save the flow data from FM8000 when it is connected with RS-232 port. The data is saved as CSV format. File name is made by the user.

### Acquire

This menu is to acquire the data from FM8000 when it is connected with RS-232 port.

**Port** – Select COM Port to access with the device.

**Baud Rate** – Select the Baud Rate which set in menu 6100. If the Baud Rate is not identical with the selected rate in menu 6100, errors may occur.

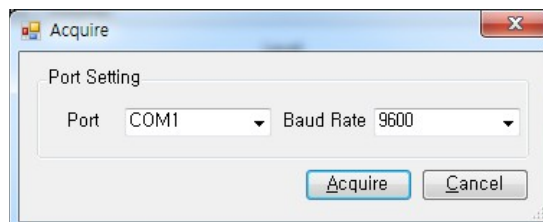

### Print

This menu is to print the selected file or the data from the device.

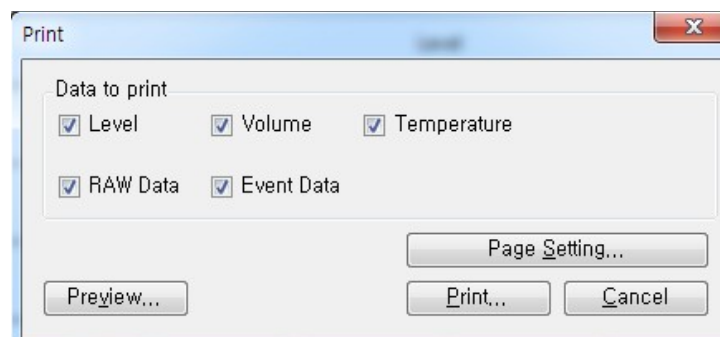

- **Data To Print** – It is selection of data range such as Level, Volume, Temperature, Raw Data, and Event Data. Level, Volume, and Temperature are printed always horizontally.
- **Page Setting** – Selection of paper size, layout, margin width, etc.
- **Preview** – Selected data is previewed.
- **Print** – Selected data is printed.

## 7.5 View

**Raw Data** - This menu is to view the raw data from the device.

Time	Level	FlowRate	TotalFlow	Temperature
2013-01-03 20:27:00	9,06 ft.	6,24 ft <sup>3</sup> /s	3,33 U.S. MG	77 °F
2013-01-03 20:27:10	9,06 ft.	6,24 ft <sup>3</sup> /s	3,33 U.S. MG	77 °F
2013-01-03 20:27:23	9,06 ft.	6,24 ft <sup>3</sup> /s	3,33 U.S. MG	77 °F
2013-01-03 20:27:33	9,06 ft.	6,24 ft <sup>3</sup> /s	3,33 U.S. MG	77 °F
2013-01-03 20:27:43	9,06 ft.	6,24 ft <sup>3</sup> /s	3,33 U.S. MG	77 °F
2013-01-03 20:27:54	9,06 ft.	6,24 ft <sup>3</sup> /s	3,33 U.S. MG	77 °F
2013-01-03 20:28:04	9,06 ft.	6,24 ft <sup>3</sup> /s	3,34 U.S. MG	77 °F
2013-01-03 20:28:14	9,06 ft.	6,24 ft <sup>3</sup> /s	3,34 U.S. MG	77 °F
2013-01-03 20:28:24	9,06 ft.	6,24 ft <sup>3</sup> /s	3,34 U.S. MG	77 °F
2013-01-03 20:28:34	9,06 ft.	6,24 ft <sup>3</sup> /s	3,34 U.S. MG	77 °F
2013-01-03 20:28:45	9,06 ft.	6,24 ft <sup>3</sup> /s	3,34 U.S. MG	77 °F
2013-01-03 20:28:55	9,06 ft.	6,24 ft <sup>3</sup> /s	3,34 U.S. MG	77 °F

**Time** – Shows the time when the data was logged. The format is Year/Month/Day, Hour:Minute:Second.

**Level** – Shows the level data.

**Flow Rate** – Shows the instant flow rate.

**Total Flow** – Shows the Total Flow Rate by selected unit in Flow Rate menu. Please refer to the table as follows. (e.g. if the Flow Rate unit is selected m<sup>3</sup>/h, the Total Flow is displayed in m<sup>3</sup> unit.)

**Temperature** – Shows the temperature data.

FLOW UNIT	TOTAL FLOW UNIT
m <sup>3</sup> /h	m <sup>3</sup>
m <sup>3</sup> /d	m <sup>3</sup>
l/min	KL(Kilo Liter)
ft <sup>3</sup> /s	ft <sup>3</sup>
GPM[US]	gal[US]
GPM[UK]	gal[UK]
MGD[US]	MGD[US]
MGD[UK]	MGD[UK]

**Event Data** – Shows the event data.

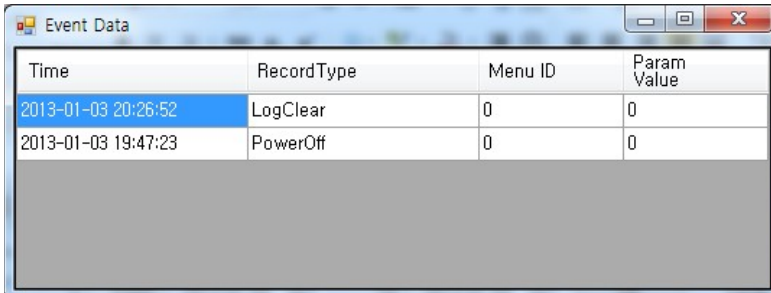

Time	RecordType	Menu ID	Param Value
2013-01-03 20:26:52	LogClear	0	0
2013-01-03 19:47:23	PowerOff	0	0

**Time** – Shows the time when the event data was logged.

**Record Type** – Shows the event classification.

**Menu ID** – Shows menu ID when the log type is Parameter Change Prev or Parameter Change Current.

**Param Value** – Shows changed menu ID and original menu ID when the log type is Parameter Change Prev or Parameter Change Current.

## 7.6 About

This menu is the information of SW copyright and the contact number of the manufacturer.

## 7.7 Troubleshooting

**Installation** – When the library; .net framework 3.5 isn't installed in the computer, the message will be occurred as below.

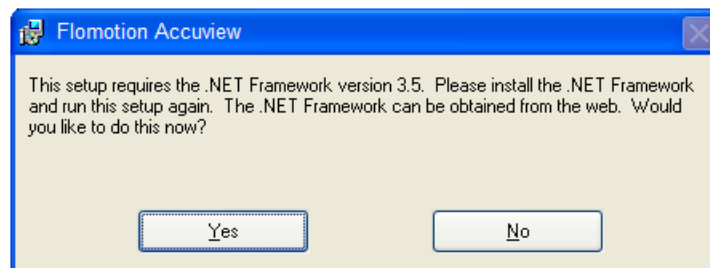

Click the YES button, download .NET Framework 3.5 from Microsoft homepage. Reinstall Accuview program.

**Open** – If the file is not suitable for the SW, the error message shows as below. Check the file if it is log file from FM8000.

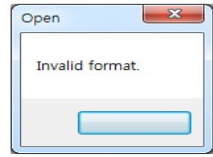

## Acquire

### **No COM port was found -**

When COM port is not found, the following error message is displayed.

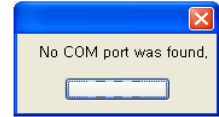

### **Device is not responding -**

When not connecting with device, the following error message is displayed.

Check the menu; Communication Setup (6100) of FM8000. It must be as follows. USE: Enable, PROTOCOL: Flomotion. Check the BAURATE of the FM8000 and the BAUDRATE of the Accuview software. It must be the same.



### **Device is not responding. Check Communication Settings.**

When not connecting with device, the following error message is displayed.

Check the menu; Communication Setup (6100) of the FM8000. It must be as follows: USE: Enable, PROTOCOL: Flomotion. Check the BAURATE of the FM8000 and the BAUDRATE of the Accuview software. It must be the same.







**FLOW ~ LEVEL ~ CHEMICAL FEED**

**Flomotion Systems, Inc.**  
**3 N. Main St, Middleport, NY 14105**  
**Toll Free: (800)909-3569 (U.S. & Canada)**  
**Tel: (716)691-3941**  
**Fax: (716)691-1253**  
**[info@flomotionsystems.com](mailto:info@flomotionsystems.com)**  
**[www.flomotionsystems.com](http://www.flomotionsystems.com)**